

Regulations of reference

NTC 2008 DM 14/01/2008

Components

The columns (A1 and A2) provide support and are made of cast iron. The lower column (A2) is octagonal and is inserted in the upper column (A1), which is decorated with twenty grooves, topped with a Corinthian capital.

The base panel is composed of a plinth (B) and a windowsill (C), both in cast iron, interconnected by a hot-dip galvanised steel sheet (D), internally reinforced and finished with a 20mm [3/4"]-thick insulated sandwich panel. The external part is decorated with two squares.

The window frames (E) are made of aluminium, opened upwards, with laminated glass (thickness: 6/7mm [1/4"]).

The two doors, made of aluminium profiles, can be opened outwards with a door width of 900mm [35 2/4"] and are equipped with a closing spring.

The shutters (F) are roller shutters and made of fully insulated steel, complete with external locks; the shutters are operated manually but assisted by a spring system that reduces their weight.

The roller shutters (G) are covered internally by a white wooden box (H) equipped with a door that can be opened for maintenance purposes and, outside, by hot-dip galvanised steel strip (I) made in a single cast with five internally decorated squares with four symmetrically arranged leaves. The frieze (I) is illuminated internally by a ceiling lamp (J) with fluorescent lamps.

The cover is made from hot-dip galvanised steel beams (M) that support a copper-plated fibreglass cover (N) and an internal false ceiling made from wooden matchboarding (O) (insulated with a 12mm [2/4"]-thick layer of expanded polyethylene and a 30mm [1 1/4"]-thick expanded polystyrene panel) which continues to the outside of the kiosk throughout the protrusion of the cantilever roof.

The cantilever roof is supported by steel beams and cast iron brackets (P).

The gutter (Q) is made of an appropriately-shaped hot-dip galvanised steel sheet, with copper outriggers, visibly covered by a decorated aluminium fascia (R).

The two decorative tops (S) is made of aluminium.

The kiosk is supplied with three central globe lights (diameter: 350mm [13 3/4"]) in opal white PMMA, with a bulb holder.

Materials

The standard colours are:

- Cast iron UNI EN 1561
- FE 360 steel UNI EN 10219-1

See the specific descriptions on the painting cycles of the materials that make

KIOSKS

ARTICLE: 3145.001.001

TECHNICAL DESCRIPTION

Decorated kiosk

Octagonal plan

Hipped roof

Standard height

up the product.

Finishes

The standard colours are:

- Neri Grey
- Green RAL 6005

Other colours are available upon request.

Weight

Standard indications

Installation

To place in operation, it is necessary to prepare a perfectly level brickwork base, measuring approximately 100mm [4"] high from the ground.

The electronic, hydraulic and flooring systems are not included.

Energy class

The energy class of the kiosks is assessed from time to time based on the place of installation, the regulations in force and the customer's specific requirements.

Warranty

Standard

3145

Kiosk plan

001

Roof type

001

Column height

Octagonal plan

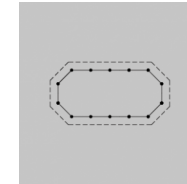

Usable area

29m² [312 sq ft]

Covered area

44m² [474 sq ft]

Modules

14

Hipped roof

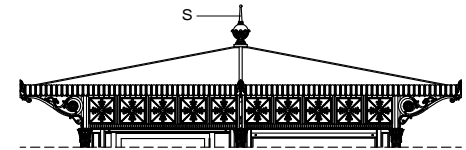

Standard height

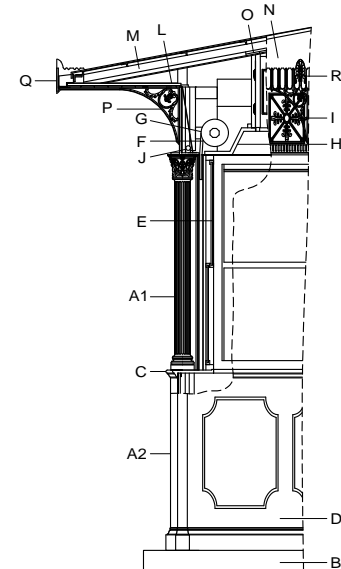

KIOSKS
ARTICLE: 3145.001.001
PLAN
SCALE 1:50

Decorated kiosk
Octagonal plan
Hipped roof
Standard height

3145	001	001
Kiosk plan	Roof type	Column height

Usable area
29m ² [312 sq ft]
Covered area
44m ² [474 sq ft]
Modules
14

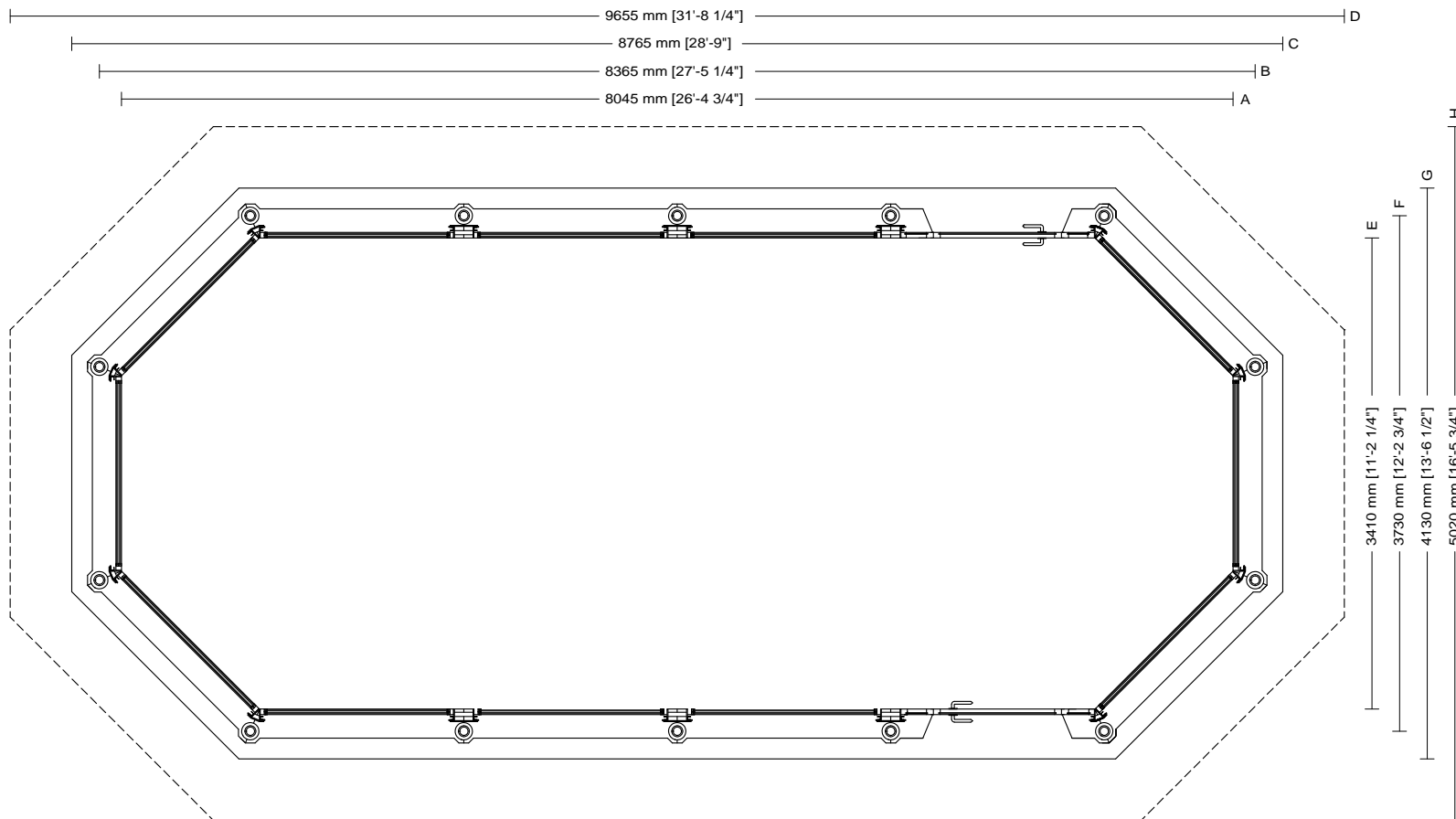

- Drawing key**
- A Internal windowsill
 - B Column axis
 - C Foundation base
 - D Roofing
 - E Internal windowsill
 - F Column axis
 - G Foundation base
 - H Roofing

KIOSKS
ARTICLE: 3145.001.001
ELEVATION
SCALE 1:50

Decorated kiosk
Octagonal plan
Hipped roof
Standard height

3145

Kiosk plan

001

Roof type

001

Column height

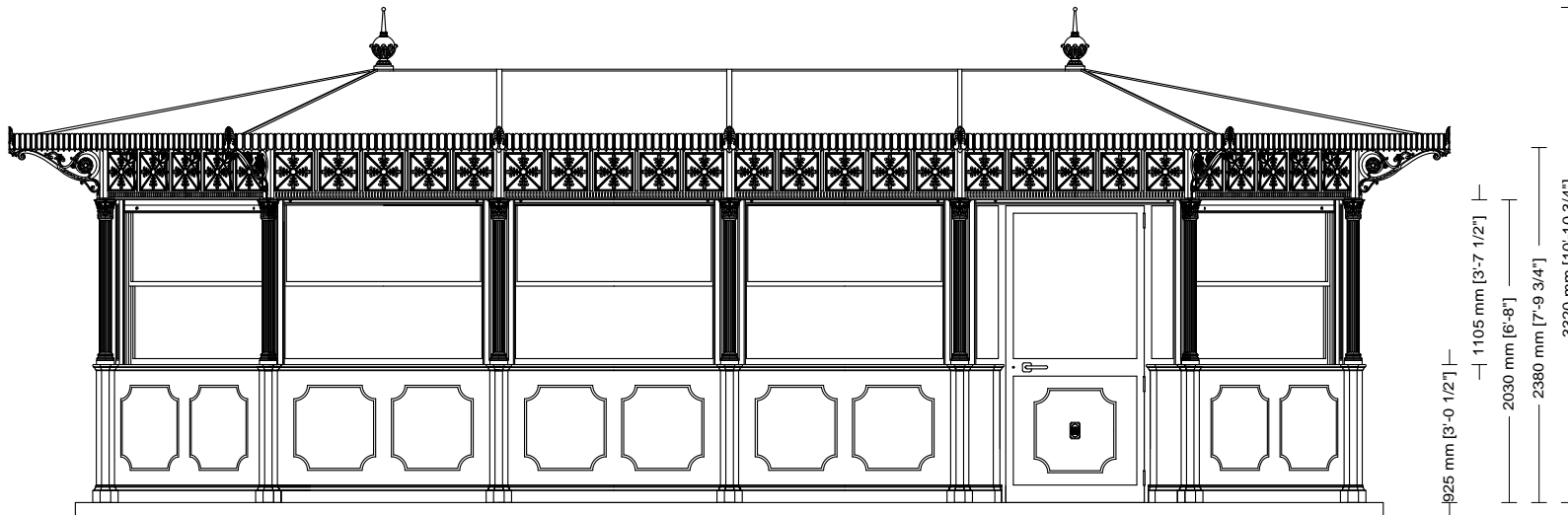

KIOSKS
ARTICLE: 3145.001.001
SECTION
SCALE 1:50

Decorated kiosk
Octagonal plan
Hipped roof
Standard height

3145

Kiosk plan

001

Roof type

001

Column height

