



SCALE A CHIOCCIOLA MODULARI IN GHISA
MODULAR CAST-IRON SPIRAL STAIRCASES
ESCALIERS EN COLIMAÇON MODULAIRES EN FONTE
MODULARE GUSSEISEN-WENDELSTREPPEN
ESCALERAS DE CARACOL MODULAR DE HIERRO FUNDIDO



- 16 Modus Color
- 20 2012, 2052, 2072 S/E
Ø 120, 140, 160 cm.
- 26 2070 S/E - Ø 160 cm.
- 38 2050 S/E - Ø 140 cm.
- 50 2010 M/E - Ø 120 cm.
- 62 Realizzazione speciali
Special projects
Réalisations spéciales
Spezialanfertigungen
Realizaciones especiales





MODUS

COLOR

La scala a chiocciola in ghisa elemento non solo funzionale, ma vero e proprio oggetto di arredamento viene reinterpretata, pur nella rigosità delle sue forme, semplicemente cambiandole colore; nuovi riflessi e luminosità per ambienti non più solo classici. Alle tinte della collezione Modus Color è possibile affiancare quella che più si avvicina ai vostri gusti.

The classic forms of cast-iron staircases, not just functional elements but essential and attractive furnishing elements, have now been reinterpreted simply by enhancing their colours, giving new accents and light to environments other than classical ones. The shades offered by the Modus Color collection can be complemented by other colours to match your tastes.

L'escalier en colimaçon en fonte, élément non seulement fonctionnel mais véritable objet d'ameublement, est réinterprété, en maintenant toute la rigueur des formes mais en en changeant simplement la couleur; de nouveaux reflets et une nouvelle luminosité pour des intérieurs non plus seulement classiques. Les teintes de la collection Modus Color peuvent être complétées par celle qui se rapproche le plus de vos goûts.





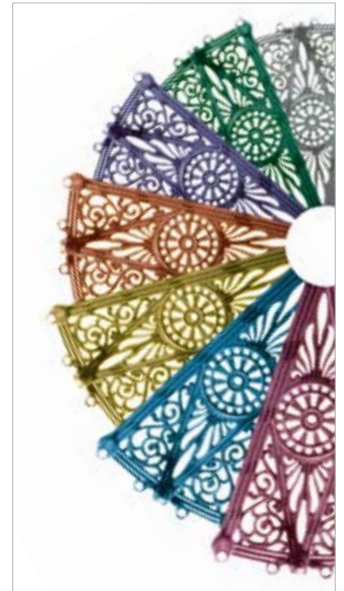

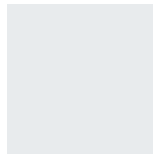

Die Gusseisen-Wendeltreppe ist nicht nur ein funktionelles Element, sondern ein echter Einrichtungsgegenstand und wird neu interpretiert; Ganz einfach durch verschiedene Farbmöglichkeiten, die neue Akzente und Highlights nicht nur in klassische Räumlichkeiten bringen. Den Farben der Modus-Color-Kollektion kann nun jene hinzugefügt werden, die Ihrem Geschmack entspricht.

La escalera de caracol de hierro colado, elemento no sólo funcional sino verdadero objeto de decoración, es reinterpretada, aun con el rigor de sus formas, simplemente cambiándola de color; nuevos reflejos y brillos para ambientes ya no sólo clásicos. Los tonos de la colección Modus Color pueden ir acompañados de los que más se adecuen a sus gustos.

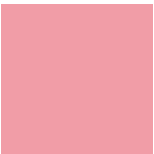

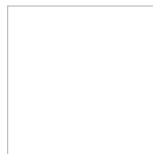

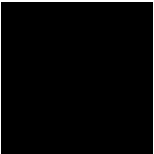
Tutti i colori RAL sono disponibili
 All RAL colours are available
 Toutes les couleurs RAL sont disponibles
 Es stehen alle RAL Farben zur Verfügung
 Todos los colores RAL a disposición

Standard Grigio Grey Modus	RAL example: 9006	6005	9001	3015	6018	2008
						
						
	9010	5003	3004	9005	6027	1023





2012-2052-2072 S

Ø 120 cm - Ø 140 cm - Ø 160 cm

Scala a chiocciola modulare con alzata regolabile tramite l'inserzione di distanziali fra i gradini. Gradino in cristallo «float» trasparente stratificato e temperato, sottogrado, colonna centrale, capiscala e ringhiere in ghisa; anima interna in acciaio; corrimano in alluminio, bulloneria in acciaio inox. Adatta per ambienti interni ed esterni. Colore standard grigio.

Modular spiral staircase with step height adjustable by inserting spacers between steps. Tempered and multi-layer float glass transparent tread, undertread decorated, central column, newel post and railings made in cast iron; steel core post; aluminium handrail, bolts and other fasteners in stainless steel. Suitable for indoor and outdoor use. Standard grey colour.

Escalier en colimaçon modulaire à contremarche réglable grâce à l'introduction d'entretoises entre les marches. Marche en cristal «float» transparent, stratifié et trempé, contremarche, colonne centrale et premiers balustres et garde-corps en fonte; âme interne en acier; main courante en aluminium, boulonnerie en acier inox. Adapté à un environnement intérieur ou extérieur. Couleur standard gris.

Modulare Wendeltreppe mit einer Steigung, die durch Einfügung von Distanzstücken zwischen den Stufen einstellbar ist. Die transparenten Trittlflächen bestehen aus gehärtetem Float-Glas; Setzfläche, Treppenspindel, Endpfosten und Geländer aus Gusseisen; Innenkern aus Stahl; Geländerpfosten aus Stahl mit Aluminiumdekor, Handlauf aus Aluminium, Schrauben und Muttern aus Edelstahl. Geeignet für Innen- und Außenräume. Farbe Standard-Grau.

Escalera de caracol modular con contrahuella regulable mediante la inserción de arandelas distanciadoras entre los escalones. Huella de varias capas de vidrio float templado transparente, tabica, columna central y principios o finales de escalera y barrotes de hierro fundido; ánima de acero; pasamanos de aluminio, pernos de acero inoxidable. Adecuada para espacios interiores y exteriores. Color estándar gris.



2012 Ø 120 cm



2072 Ø 160 cm



2012-2052-2072 E

Ø 120 cm - Ø 140 cm - Ø 160 cm

Scala a chiocciola modulare con alzata regolabile tramite l'inserzione di distanziali fra i gradini. Gradino in cristallo «float» trasparente stratificato e temperato, colonna centrale, capiscala e ringhiere in ghisa; anima interna in acciaio; corrimano in alluminio, bulloneria in acciaio inox. Adatta per ambienti interni ed esterni. Colore standard grigio.

Modular spiral staircase with step height adjustable by inserting spacers between steps. Tempered and multi-layer float glass transparent tread, central column, newel post and railings made in cast iron; steel core post; aluminium handrail, bolts and other fasteners in stainless steel. Suitable for indoor and outdoor use. Standard grey colour.

Escalier en colimaçon modulaire à contremarche réglable grâce à l'introduction d'entretoises entre les marches. Marche en cristal «float» transparent, stratifié et trempé, colonne centrale et premiers balustres et garde-corps en fonte; âme interne en acier; main courante en aluminium, boulonnerie en acier inox. Adapté à un environnement intérieur ou extérieur. Couleur standard gris.

Modulare Wendeltreppe mit einer Steigung, die durch Einfügung von Distanzstücken zwischen den Stufen einstellbar ist. Die transparenten Trittplächen bestehen aus gehärtetem Float-Glas; Treppenspindel, Endpfosten und Geländer aus Gusseisen; Innenkern aus Stahl; Geländerpfosten aus Stahl mit Aluminiumdekor, Handlauf aus Aluminium, Schrauben und Muttern aus Edelstahl. Geeignet für Innen- und Außenräume. Farbe Standard-Grau.

Escalera de caracol modular con contrahuella regulable mediante la inserción de arandelas distanciadoras entre los escalones. Huella de varias capas de vidrio float templado transparente, columna central y principios o finales de escalera y barrotes de hierro fundido; ánima de acero; pasamanos de aluminio, pernos de acero inoxidable. Adecuada para espacios interiores y exteriores. Color estándar gris.





2012, 2052, 2072 S/E
 Ø 120, Ø 140, Ø 160 cm

Pianerottoli
Landings
Marches palières
Treppenausstieg
Rellanos

Colonnine
Balusters
Balustres
Streben
Barrotes

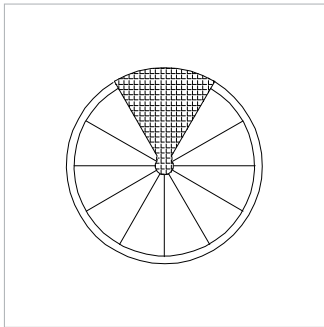

Circolare in ghisa
 Round in cast-iron
 Circulaire en fonte
 Rund aus Gusseisen
 Circular de hierro fundido

Senza decoro
 Without ornament
 Sans ornement
 Ohne Verzierung
 Sin decoración

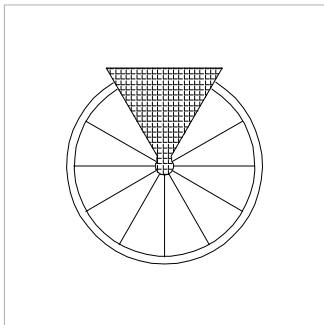
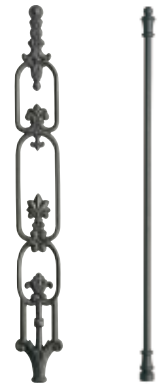
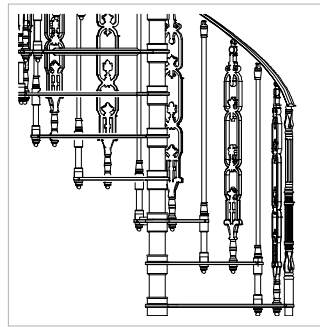

Triangolare in ghisa e acciaio
 Triangular in cast-iron and steel
 Triangulaire en fonte et acier
 Dreieckig aus Gusseisen und Stahl
 Triangular de hierro fundido y acero

Decoro geometrico
 Geometrical ornament
 Ornement géométrique
 Geometrische Motive
 Decoración geométrica

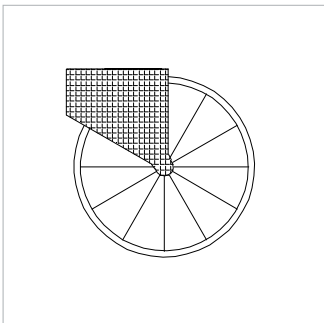
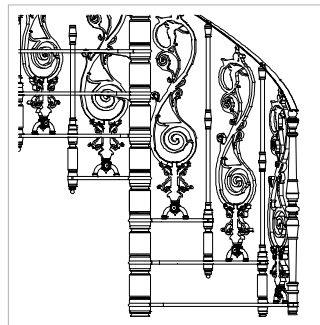

Trapezoidale in ghisa e acciaio
 Trapezoid in cast iron and steel
 Trapézoïdale en fonte et acier
 Trapezförmig aus Gusseisen und Stahl
 Trapezoidal de hierro fundido y acero

Decoro floreale
 Floral ornament
 Ornement floral
 Blumenverzierung
 Decoración floral

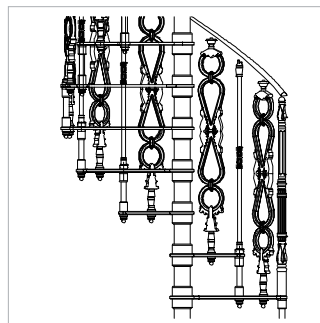

Elementi disponibili vedere pag. 92
 Available elements see pages 92
 Éléments disponibles voir pag 92
 Verfügbare Einzelteile siehe Seite 92
 Elementos disponibles ver pag. 92

2012, 2052, 2072 S/E
 Ø 120, Ø 140, Ø 160 cm

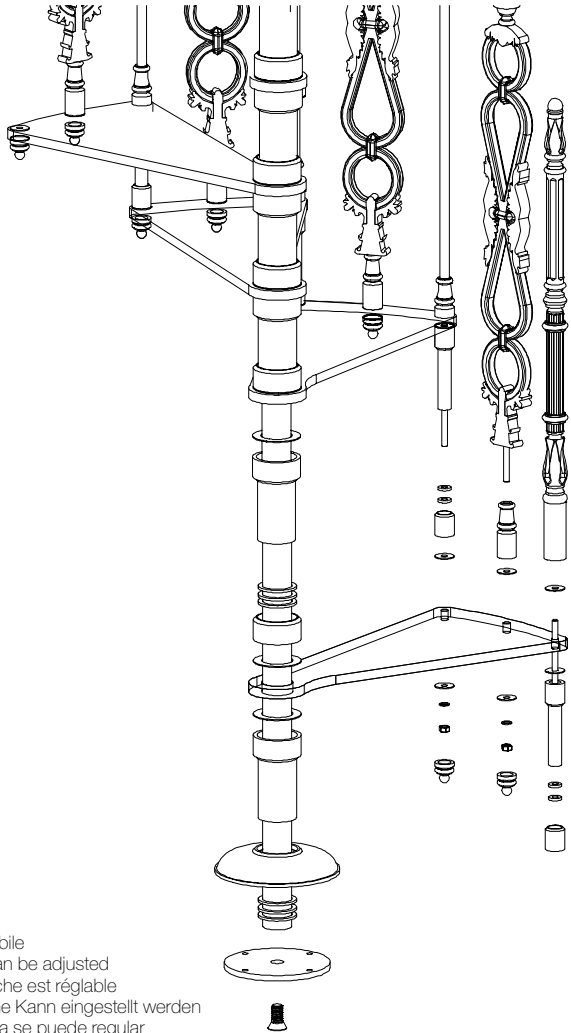

Alzata registrabile
 Step height can be adjusted
 La contremarche est réglable
 Die Stufenhöhe kann eingestellt werden
 La contrahuella se puede regular

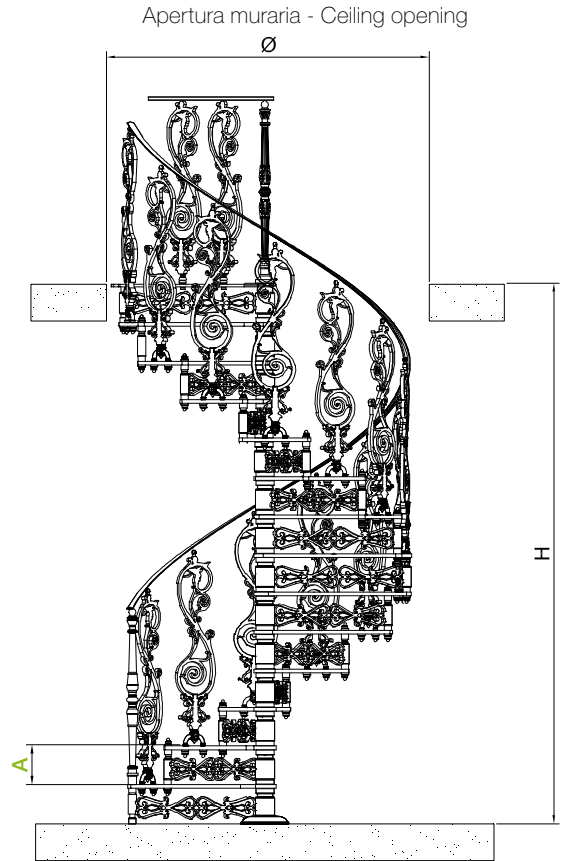

Gradini per giro
 Steps per full turn
 Marches par tour
 Stufenanzahl pro Drehung
 Escalones por vuelta

14

(A) Alzata gradino in cm. - Step height in cm - Stufenhöhe in cm. - Contremarche en cm. - Contrahuella del escalón en cm

2012 Ø 120 cm	2052 Ø 140 cm	2072 Ø 160 cm							
kg. max	kg. max	kg. max			21,0	21,5	22,0	22,5	23,0
280	344	375	N° alzata totali - Total number of steps	10	210,0	215,0	220,0	225,0	230,0
305	375	410	N° lire de contremarches totales	11	231,0	236,5	242,0	247,5	253,0
330	406	445	Gesamtzahl der Treppenstufen - N° total de contrahuellas	12	252,0	258,0	264,0	270,0	276,0
355	437	480		13	273,0	279,5	286,0	292,5	299,0
380	468	515		14	294,0	301,0	308,0	315,0	322,0
405	499	550		15	315,0	322,5	330,0	337,5	345,0
430	530	585		16	336,0	344,0	352,0	360,0	368,0

(H) Altezza scala in cm. - Staircase height in cm.
 Treppenhöhe in cm.
 Hauteur de l'escalier en cm - Altura de la escalera en cm.



2070 S

Ø 160 cm

Scala a chiocciola modulare con alzata regolabile tramite l'inserzione di distanziali fra i gradini. Gradino in ghisa sferoidale, sottogrado, colonna centrale e capiscala in ghisa; anima interna in acciaio; colonnine (vedere pag. 33), corrimano in alluminio, bulloneria in acciaio inox. Adatta per ambienti interni ed esterni. Colore standard grigio.

Modular spiral staircase with step height adjustable by inserting spacers between steps. Tread in nodular cast iron, undertread decorated, central column, newel posts in cast iron; steel core post; balustrades (see page 33) aluminium handrail, bolts and other fasteners in stainless steel. Suitable for indoor and outdoor use. Standard grey colour.

Escalier en colimaçon modulaire à contremarche réglable grâce à l'introduction d'entretoises entre les marches. Marche en fonte sphéroïdale, contremarche, colonne centrale et premiers balustres en fonte; âme interne en acier; balustres (voir à la page 33) main courante en aluminium, boulonnerie en acier inox. Adapté à un environnement intérieur ou extérieur. Couleur standard gris.

Modulare Wendeltreppe mit einer Steigung, die durch Einfügung von Distanzstücken zwischen den Stufen verändert werden kann ; Trittflächen aus Kugelgraphitgusseisen; Setzfläche, Treppenspindel und Endpfosten aus Gusseisen; Innenkern aus Stahl; Geländer und Geländerpfosten aus Stahl, Handlauf aus Aluminium, Schrauben und Muttern aus Edelstahl. Geeignet für Innen- und Außenräume. Farbe Standard-Grau.

Escalera de caracol modular con contrahuella regulable mediante la inserción de arandelas distanciadoras entre los escalones. Huella de hierro fundido esférico, tabica, columna central y principios o finales de escalera de hierro fundido; ánima de acero; barrotes (ver a la pag. 33) pasamanos de aluminio, pernos de acero inoxidable. Adecuada para espacios interiores y exteriores. Color estándar gris.

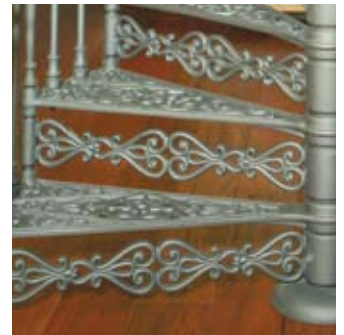



2070 E

Ø 160 cm

Scala a chiocciola modulare con alzata regolabile tramite l'inserzione di distanziali fra i gradini. Gradino in ghisa sferoidale, colonna centrale e capiscala in ghisa ; anima interna in acciaio; colonnine (vedere pag. 33), corrimano in alluminio, bulloneria in acciaio inox. Adatta per ambienti interni ed esterni. Colore standard grigio.

Modular spiral staircase with step height adjustable by inserting spacers between steps. Tread in nodular cast iron, central column, newel posts in cast iron; steel core post; balustrades (see page 33) aluminium handrail, bolts and other fasteners in stainless steel. Suitable for indoor and outdoor use. Standard grey colour.

Escalier en colimaçon modulaire à contremarche réglable grâce à l'introduction d'entretoises entre les marches. Marche en fonte sphéroïdale, colonne centrale et premiers balustres en fonte; âme interne en acier; balustres (voir à la page 33) main courante en aluminium, boulonnerie en acier inox. Adapté à un environnement intérieur ou extérieur. Couleur standard gris.

Modulare Wendeltreppe mit einer Steigung, die durch Einfügung von Distanzstücken zwischen den Stufen verändert werden kann; Trittlflächen aus Kugelgraphitgusseisen; Treppenspindel, Endpfosten aus Gusseisen; Innenkern aus Stahl; Geländer und Geländerpfosten aus Stahl, Handlauf aus Aluminium, Schrauben und Muttern aus Edelstahl. Geeignet für Innen- und Außenräume. Farbe Standard-Grau.

Escalera de caracol modular con contrahuella regulable mediante la inserción de arandelas distanciadoras entre los escalones. Huella de hierro fundido esferoidal, columna central y principios o finales de escalera de hierro fundido; âme de acero; barrotes (ver a la pag. 33) pasamanos de aluminio, pernos de acero inoxidable. Adecuada para espacios interiores y exteriores. Color estándar gris.



□ 2070 S/E
Ø 160 cm

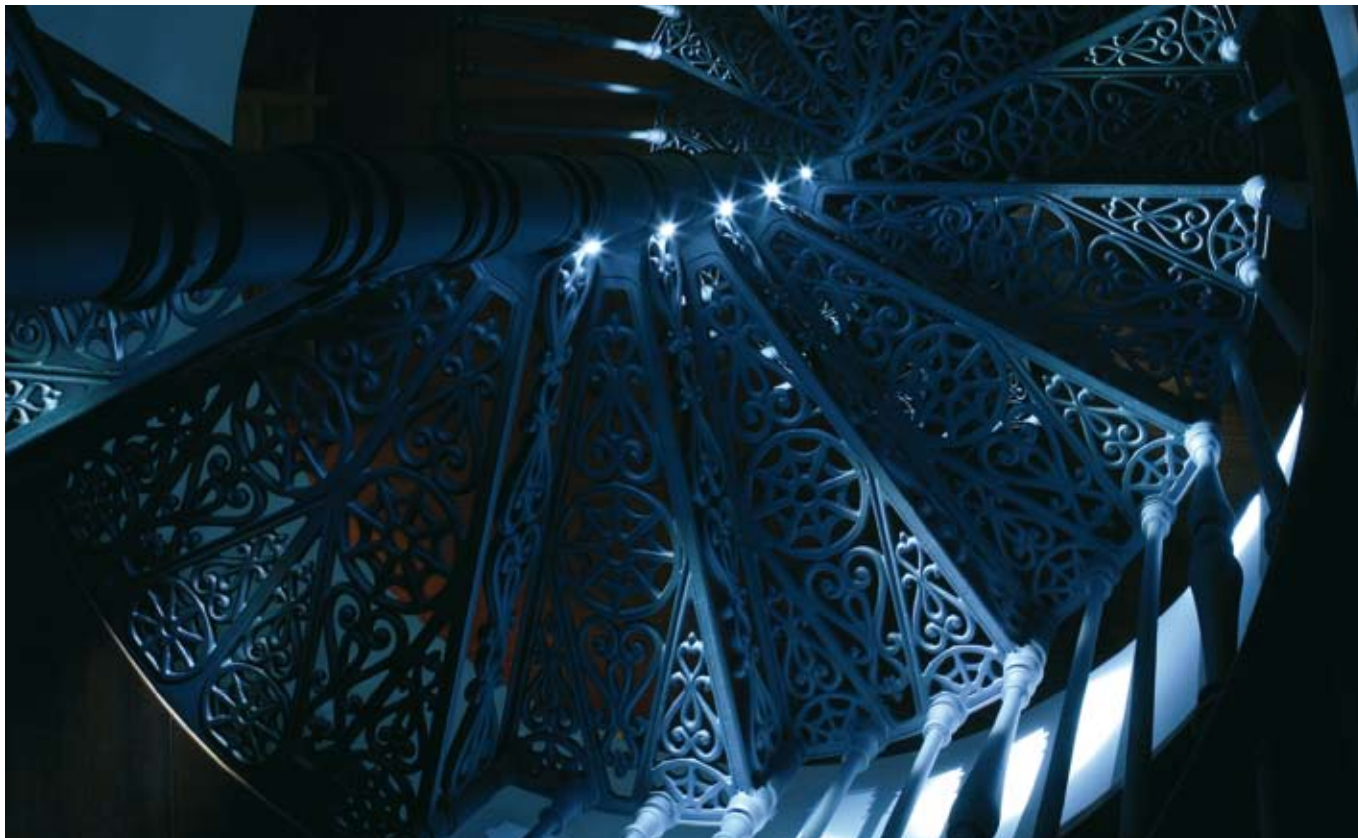

Spirale di luce
The spiral of light
Spirale de lumière
Lichtspiralen
Espiral de luz

Alla funzione di collegamento dei vari ambienti è associato un innovativo sistema di illuminazione a led opzionale (solo per interni).

Its function of linking different areas has been enhanced by an innovative led lighting system as optional (indoor use only).

A la función de liaison entre les différentes pièces est associé un innovant système d'éclairage avec des leds en option (seulement à l'intérieur)

Neben der Verbindungsfunktion kann die Wendeltreppe auch mit einer Beleuchtungsfunktion ausgestattet werden - optional ist ein innovatives Beleuchtungssystem mit LED's erhältlich (nur für Innen).

A la función de conexión de los varios ámbitos es agregado un innovador sistema de iluminación con led opcional (solo para interiores).



□ 2070 S/E
 Ø 160 cm

Pianerottoli
Landings
Marches palières
Treppenausstieg
Rellanos

Pianerottolo di partenza (opzionale)
Bottom landing (optional)
Palier de départ (en option)
Einstiegspodest (auf Wunsch)
Rellano de salida (opcional)

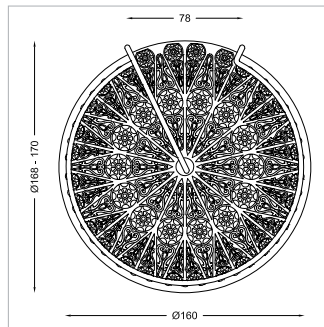

Circolare in ghisa
 Round in cast-iron
 Circulaire en fonte
 Rund aus Gusseisen
 Circular de hierro fundido

Ingresso scala standard
 Standard staircase entrance
 Accès escalier standard
 Standard Treppeneingang
 Entrada de escalera estándar

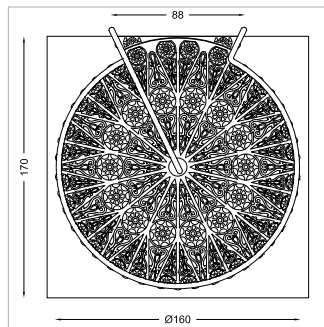
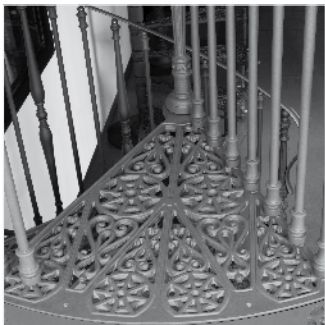
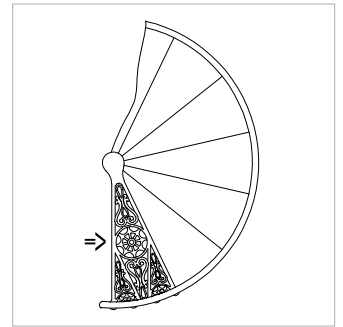

Triangolare in ghisa e acciaio
 Triangular in cast-iron and steel
 Triangulaire en fonte et acier
 Dreieckig aus Gusseisen und Stahl
 Triangular de hierro fundido y acero

Ingresso con pianerottolo di partenza
 Starting with landing
 Accès avec palier de départ
 Mit Einstiegspodest
 Entrada con rellano de inicio

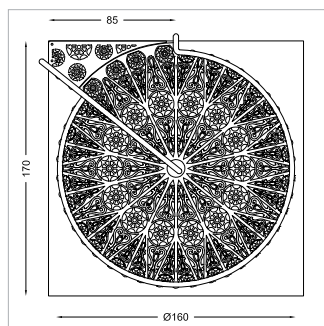
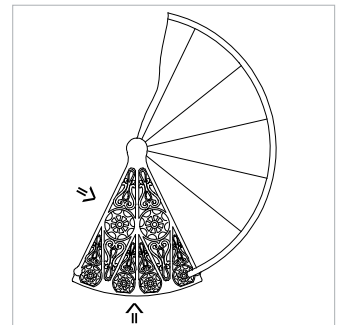

Trapezoidale in ghisa e acciaio
 Trapezoid in cast iron and steel
 Trapézoïdale en fonte et acier
 Trapezförmig aus Gusseisen und Stahl
 Trapezoidal de hierro fundido y acero

2070 S/E
Ø 160 cm



Colonnine
Balusters
Balustres
Streben
Barrotes



In ghisa
In cast-iron
En fonte
Gusseisen
De hierro fundido

In acciaio senza decoro
In steel without ornament
En acier sans ornement
Stahl ohne Verzierung
De acero sin decoración

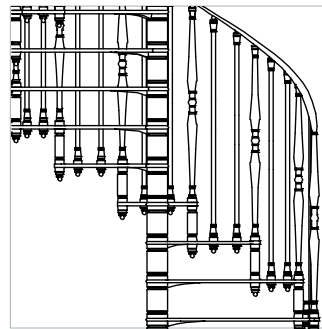

In ghisa e acciaio
In cast-iron and steel
En fonte et acier
Gusseisen und Stahl
De hierro fundido y acero

In acciaio decoro geometrico
In steel geometrical ornament
En acier ornement géométrique
Stahl geometrische Motive
De acero decoración geométrica

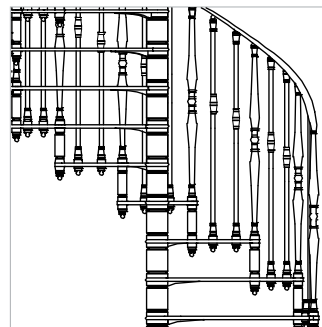

In vetro
In glass
En verre
Aus Glas
De vidrio

In acciaio decoro floreale
In steel floral ornament
En acier ornement floral
Stahl blumenverzierung
De acero decoración floral

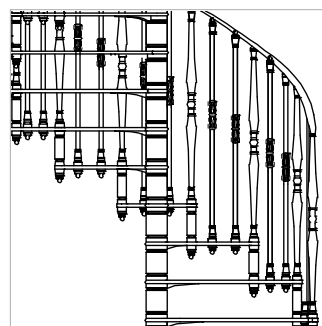

□ 2070 S/E
 Ø 160 cm

Balaustra di protezione
Protective railings
Garde-corps
Schutzbalustraden
Balustradas de protección

Corrimano in alluminio disponibile in diverse metrature
 Aluminium handrail available in different lengths
 Main courante en aluminium disponible en différents métrages
 Handlauf aus Aluminium in verschiedenen Längen lieferbar
 Pasamanos de aluminio disponible en varios metrajes

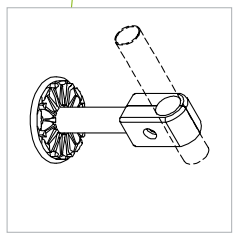
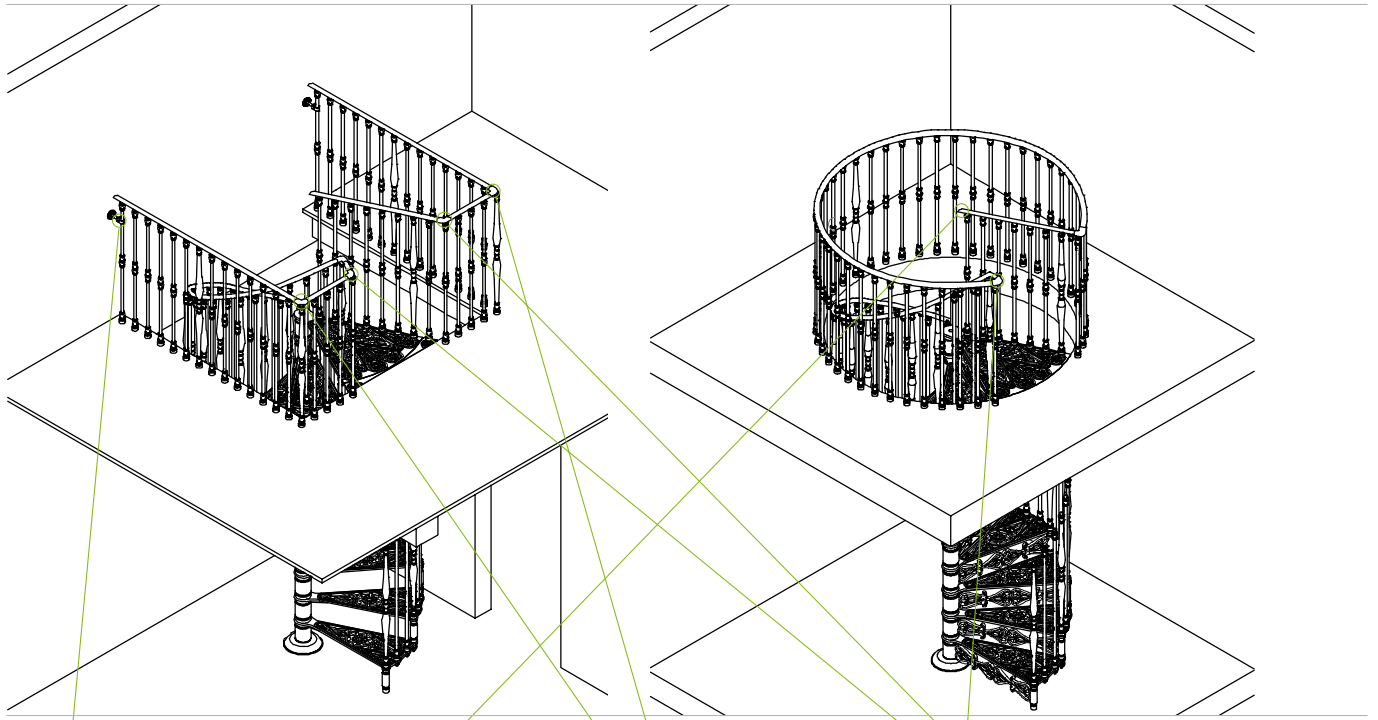

S0095.CSP.0000S

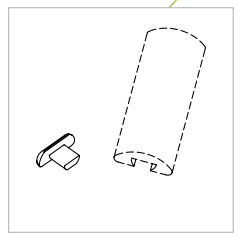

S0016.CSP.0000S

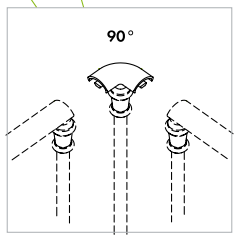

S0088.CSP.0000S

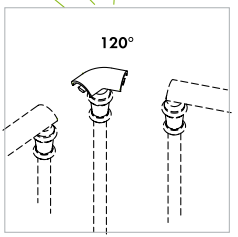

S0089.CSP.0000S

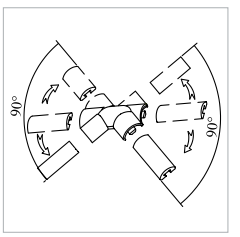

S0035.CSP.0000S

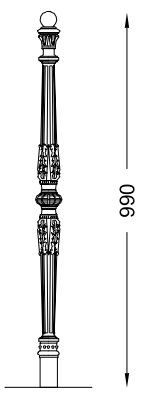

S0094.CSP.0000S

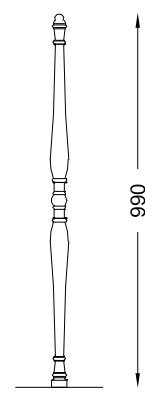

S0075.CSP.0000S

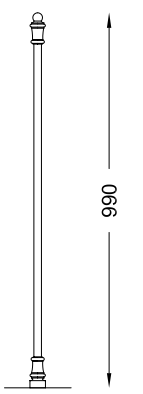

S0019.CSP.0000LS

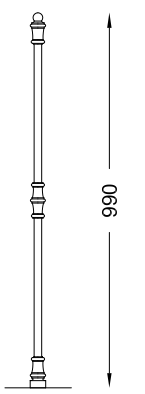

S0019.CSP.0000TS

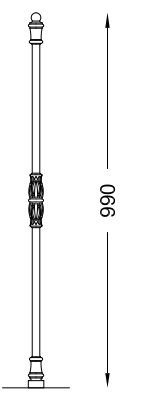

S0019.CSP.0000FS



2070 S/E
 Ø 160 cm

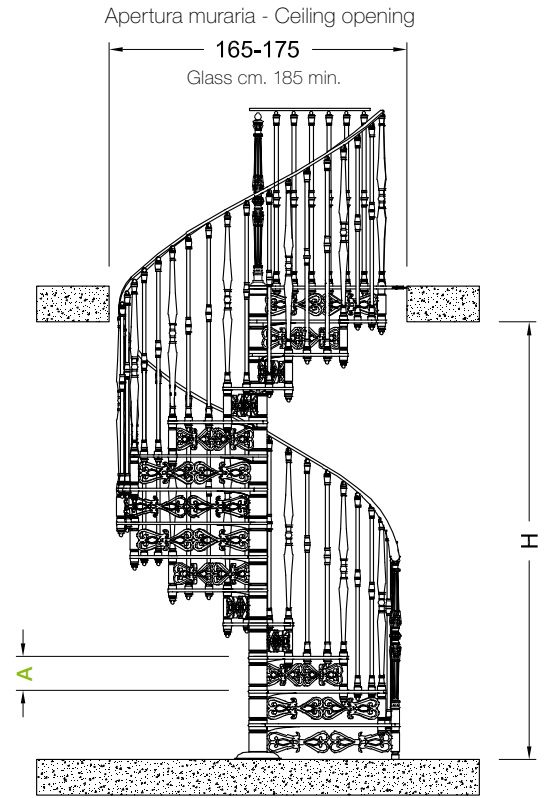
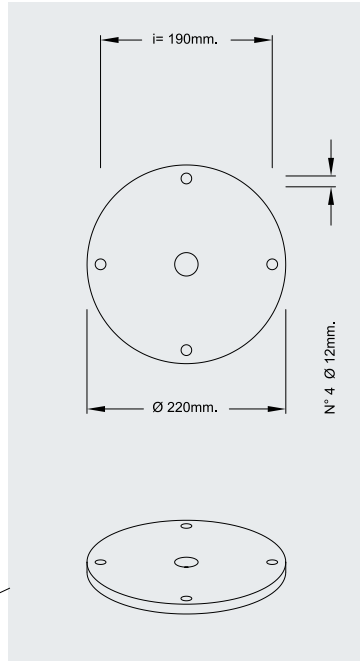
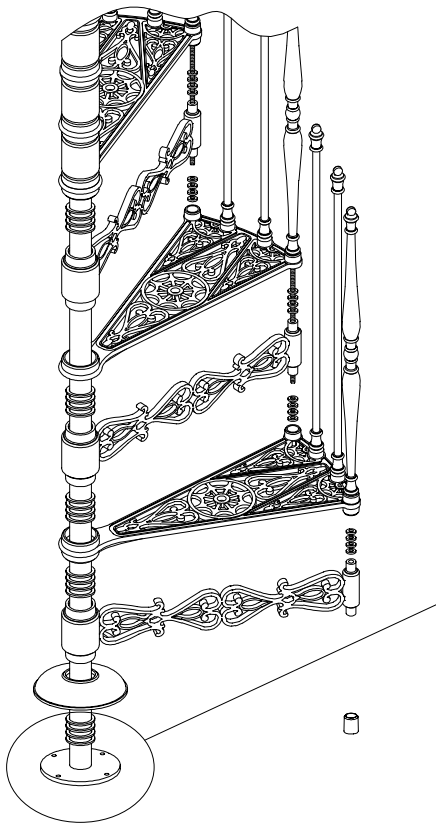

Alzata registrabile
 Step height can be adjusted
 La contremarche est réglable
 Die Stufenhöhe kann eingestellt werden
 La contrahuella se puede regular

Gradini per giro
 Steps per full turn
 Marches par tour
 Stufenanzahl pro Drehung
 Escalones por vuelta

14

(A) Alzata gradino in cm. - Step height in cm - Stufenhöhe in cm. Contremarche en cm. - Contrahuella del escalón en cm

kg. max		19,0	19,5	20,0	20,5	21,0	21,5	22,0	22,5	23,0	
375	10	192,0	196,0	200,5	205,0	210,0	215,0	220,0	225,0	230,0	N° alzate totali - Total number of steps N.º de contremarches totales Gesamtzahl der Treppenstufen - N° total de contrahuellas (H) Altezza scala in cm. - Staircase height in cm. Treppenhöhe in cm. Hauteur de l'escalier en cm. - Altura de la escalera en cm.
410	11	211,0	215,5	220,5	225,5	231,0	236,5	242,0	247,5	253,0	
445	12	n.d.	n.d.	n.d.	246,0	252,0	258,0	264,0	270,0	266,0	
480	13	249,0	254,5	260,5	266,5	273,0	279,5	286,0	292,5	299,0	
515	14	268,0	274,0	280,5	287,0	294,0	301,0	308,0	315,0	322,0	
550	15	287,0	293,5	300,5	307,5	315,0	322,5	330,0	n.d.	n.d.	
585	16	n.d.	313,0	320,5	328,0	336,0	344,0	352,0	360,0	368,0	
620	17	325,0	332,5	340,5	348,5	357,0	365,5	374,0	382,5	391,0	
655	18	344,0	352,0	360,5	369,0	378,0	387,0	396,0	n.d.	n.d.	
690	19	n.d.	371,5	380,5	389,5	399,0	408,5	418,0	427,5	437,0	
725	20	382,0	391,0	400,5	410,0	420,0	430,0	n.d.	n.d.	n.d.	





2050 S

Ø 140 cm

Scala a chiocciola modulare con alzata regolabile tramite l'inserzione di distanziali fra i gradini. Gradino in ghisa sferoidale, sottogrado, colonna centrale e capiscala in ghisa anima interna in acciaio; colonnine (vedere pag. 45), corrimano in alluminio, bulloneria in acciaio inox. Adatta per ambienti interni ed esterni. Colore standard grigio.

Modular spiral staircase with step height adjustable by inserting spacers between steps. Tread in nodular cast iron, undertread decorated, central column, newel posts in cast iron; steel core post; balustrades (see page 45) aluminium handrail, bolts and other fasteners in stainless steel. Suitable for indoor and outdoor use. Standard grey colour.

Escalier en colimaçon modulaire à contremarche réglable grâce à l'introduction d'entretoises entre les marches. Marche en fonte sphéroïdale, contremarche, colonne centrale et premiers balustres en fonte; âme interne en acier; balustres (voir à la page 45) main courante en aluminium, boulonnerie en acier inox. Adapté à un environnement intérieur ou extérieur. Couleur standard gris.

Modulare Wendeltreppe mit einer Steigung, die durch Einfügung von Distanzstücken zwischen den Stufen verändert werden kann; Trittflächen aus Kugelgraphitgusseisen; Setzfläche, Treppenspindel und Endpfosten aus Gusseisen; Innenkern aus Stahl; Geländer und Geländerpfosten aus Stahl, Handlauf aus Aluminium, Schrauben und Muttern aus Edelstahl. Geeignet für Innen- und Außenräume. Farbe Standard-Grau.

Escalera de caracol modular con contrahuella regulable mediante la inserción de arandelas distanciadoras entre los escalones. Huella de hierro fundido esférico, tabica, columna central y principios o finales de escalera de hierro fundido; ánima de acero; barrotes (ver a la pag. 45) pasamanos de aluminio, pernos de acero inoxidable. Adecuada para espacios interiores y exteriores. Color estándar gris.

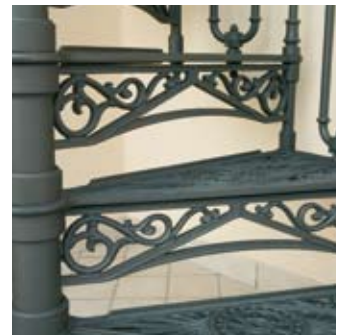



2050 E

Ø 140 cm

Scala a chiocciola modulare con alzata regolabile tramite l'inserzione di distanziali fra i gradini. Gradino in ghisa sferoidale, colonna centrale e capiscala in ghisa; anima interna in acciaio; colonnine (vedere pag. 45), corrimano in alluminio, bulloneria in acciaio inox. Adatta per ambienti interni ed esterni. Colore standard grigio.

Modular spiral staircase with step height adjustable by inserting spacers between steps. Tread in nodular cast iron, central column, newel posts in cast iron; steel core post; balustrades (see page 45) aluminium handrail, bolts and other fasteners in stainless steel. Suitable for indoor and outdoor use. Standard grey colour.

Escalier en colimaçon modulaire à contremarche réglable grâce à l'introduction d'entretoises entre les marches. Marche en fonte sphéroïdale, colonne centrale et premiers balustres en fonte; âme interne en acier; balustres (voir à la page 45) main courante en aluminium, boulonnerie en acier inox. Adapté à un environnement intérieur ou extérieur. Couleur standard gris.

Modulare Wendeltreppe mit einer Steigung, die durch Einfügung von Distanzstücken zwischen den Stufen verändert werden kann; Trittflächen aus Kugelgraphitgusseisen; Treppenspindel, Endpfosten aus Gusseisen; Innenkern aus Stahl; Geländer und Geländerpfosten aus Stahl, Handlauf aus Aluminium, Schrauben und Muttern aus Edelstahl. Geeignet für Innen- und Außenräume. Farbe Standard-Grau.

Escalera de caracol modular con contrahuella regulable mediante la inserción de arandelas distanciadoras entre los escalones. Huella de hierro fundido esferoidal, columna central y principios o finales de escalera de hierro fundido; ánima de acero; barrotes (ver a la pag. 45) pasamanos de aluminio, pernos de acero inoxidable. Adecuada para espacios interiores y exteriores. Color estándar gris.



□ 2050 S/E
Ø 140 cm

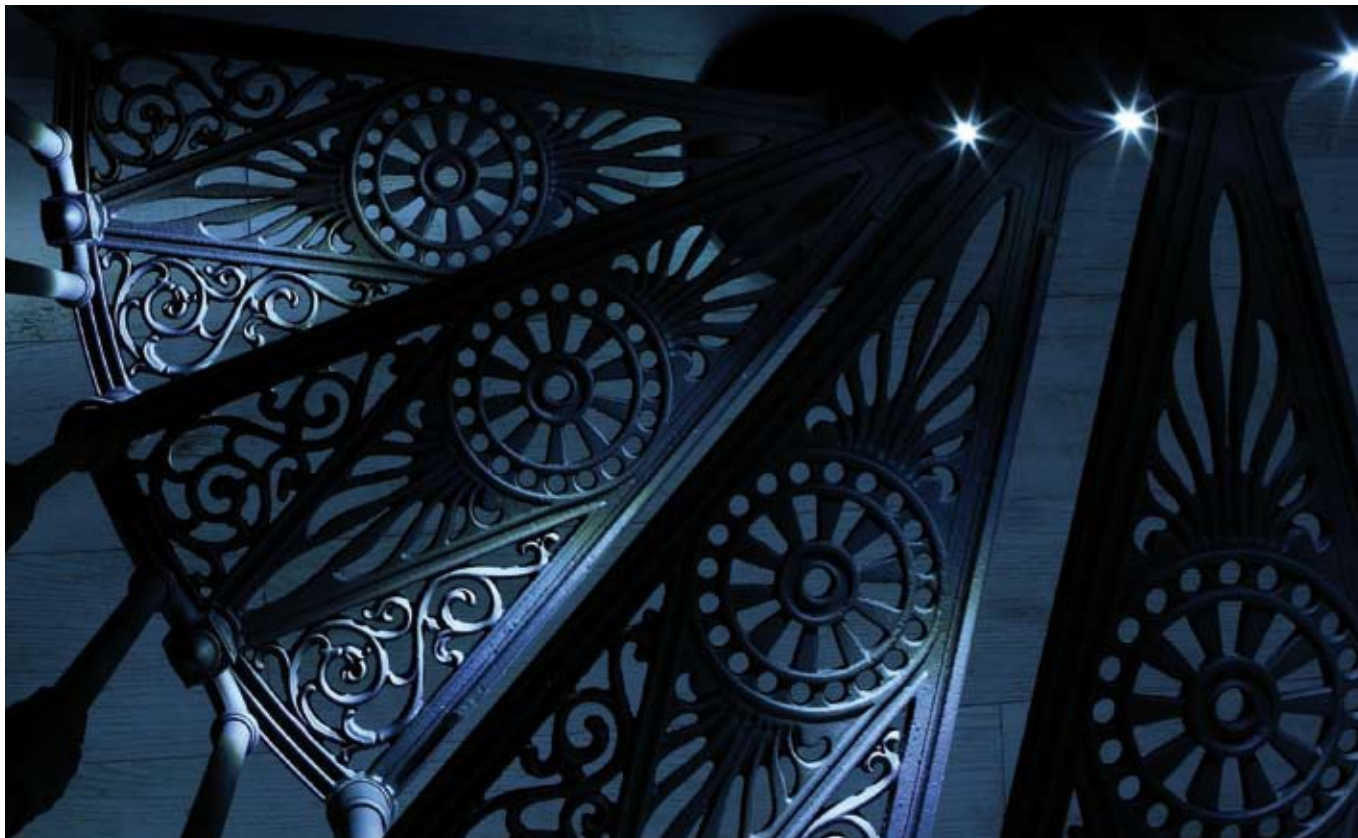

Spirale di luce
The spiral of light
Spirale de lumière
Lichtspiralen
Espiral de luz

Alla funzione di collegamento dei vari ambienti è associato un innovativo sistema di illuminazione a led opzionale (solo per interni).

Its function of linking different areas has been enhanced by an innovative led lighting system as optional (indoor use only).

A la fonction de liaison entre les différentes pièces est associé un innovant système d'éclairage avec des leds en option (seulement à l'intérieur)

Neben der Verbindungsfunktion kann die Wendeltreppe auch mit einer Beleuchtungsfunktion ausgestattet werden
- optional ist ein innovatives Beleuchtungssystem mit LED's erhältlich (nur für Innen).

A la función de conexión de los varios ámbitos es agregado un innovador sistema de iluminación con led opcional (solo para interiores).



□ 2050 S/E
 Ø 140 cm

Pianerottoli
Landings
Marches palières
Treppenausstieg
Rellanos

Pianerottolo di partenza (opzionale)
Bottom landing (optional)
Palier de départ (en option)
Einstiegspodest (auf Wunsch)
Rellano de salida (opcional)

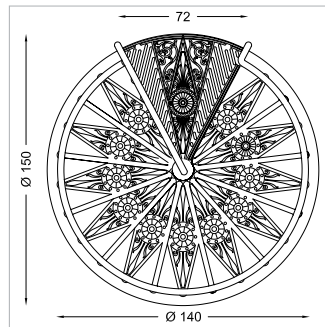

Circolare in ghisa
 Round in cast-iron
 Circulaire en fonte
 Rund aus Gusseisen
 Circular de hierro fundido

Ingresso scala standard
 Standard staircase entrance
 Accès escalier standard
 Standard Treppeneingang
 Entrada de escalera estándar

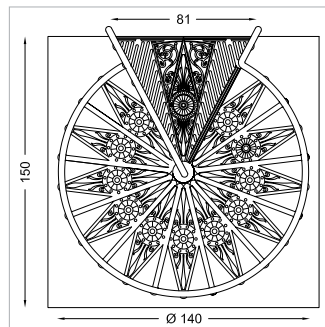
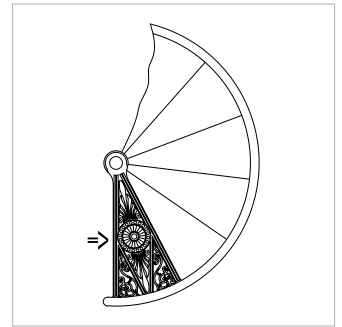

Triangolare in ghisa
 Triangular in cast-iron
 Triangulaire en fonte
 Dreieckig aus Gusseisen
 Triangular de hierro fundido

Ingresso con pianerottolo di partenza
 Starting with landing
 Accès avec palier de départ
 Mit Einstiegspodest
 Entrada con rellano de inicio

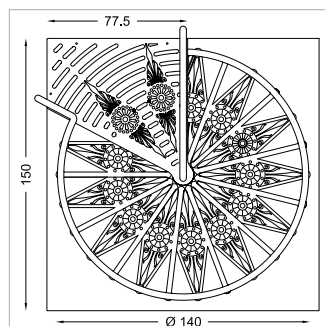
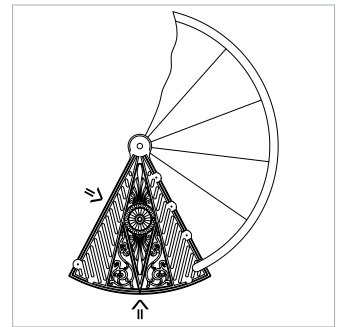

Trapezoidale in acciaio
 Trapezoid in steel
 Trapézoïdale en acier
 Trapezförmig aus Stahl
 Trapezoidal de acero

2050 S/E
Ø 140 cm



Colonnine
Balusters
Balustres
Streben
Barrotes



In ghisa
In cast-iron
En fonte
Gusseisen
De hierro fundido

In acciaio senza decoro
In steel without ornament
En acier sans ornement
Stahl ohne Verzierung
De acero sin decoración

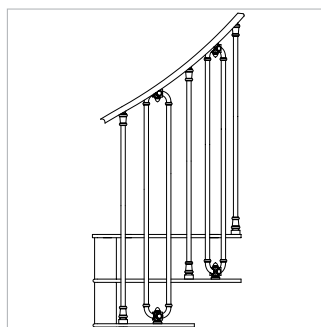

In ghisa e acciaio
In cast-iron and steel
En fonte et acier
Gusseisen und Stahl
De hierro fundido y acero

In acciaio decoro geometrico
In steel geometrical ornament
En acier ornement géométrique
Stahl geometrische Motive
De acero decoración geométrica

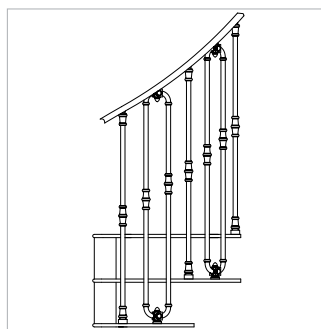

In vetro
In glass
En verre
Aus Glas
De vidrio

In acciaio decoro floreale
In steel floral ornament
En acier ornement floral
Stahl blumenverzierung
De acero decoración floral

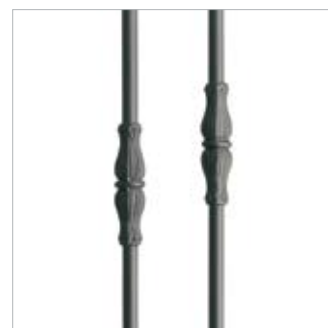
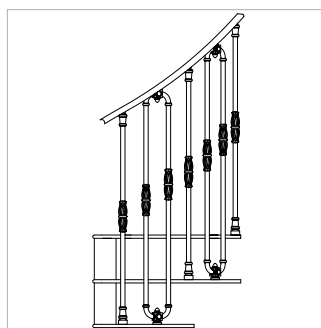

2050 S/E
 Ø 140 cm

Balaustra di protezione
Protective railings
Garde-corps
Schutzbalustraden
Balustradas de protección

Corrimano in alluminio disponibile in diverse metrature
 Aluminium handrail available in different lengths
 Main courante en aluminium disponible en différents métrages
 Handlauf aus Aluminium in verschiedenen Längen lieferbar
 Pasamanos de aluminio disponible en varios metrajes

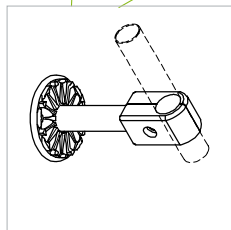
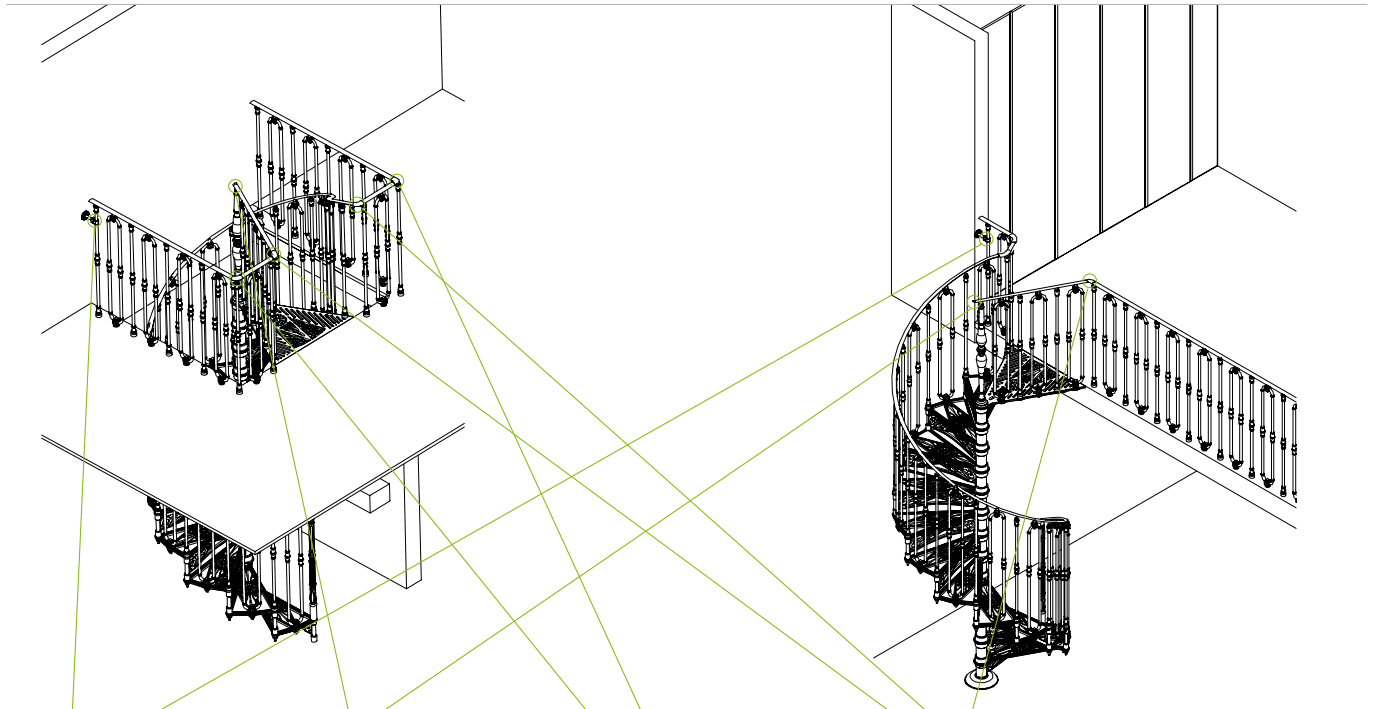

S0095.CSP.0000S

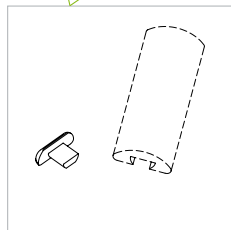

S0016.CSP.0000S

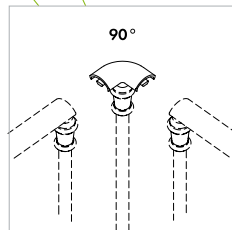

S0088.CSP.0000S

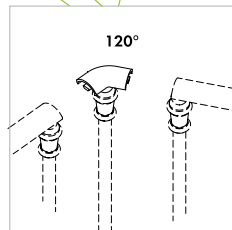

S0089.CSP.0000S

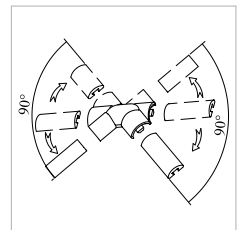

S0035.CSP.0000S

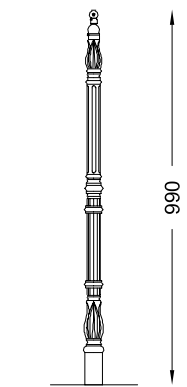

S0091.CSP.0000S

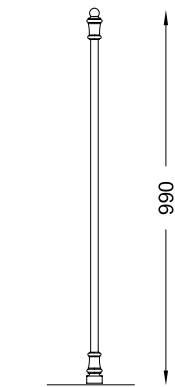

S0019.CSP.00LS

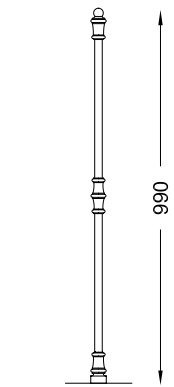

S0019.CSP.000TS

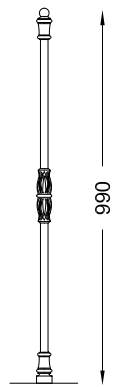

S0019.CSP.000FS

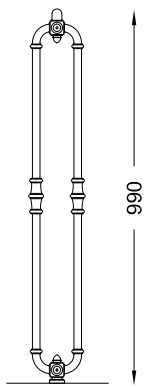

990



2050 S/E
 Ø 140 cm

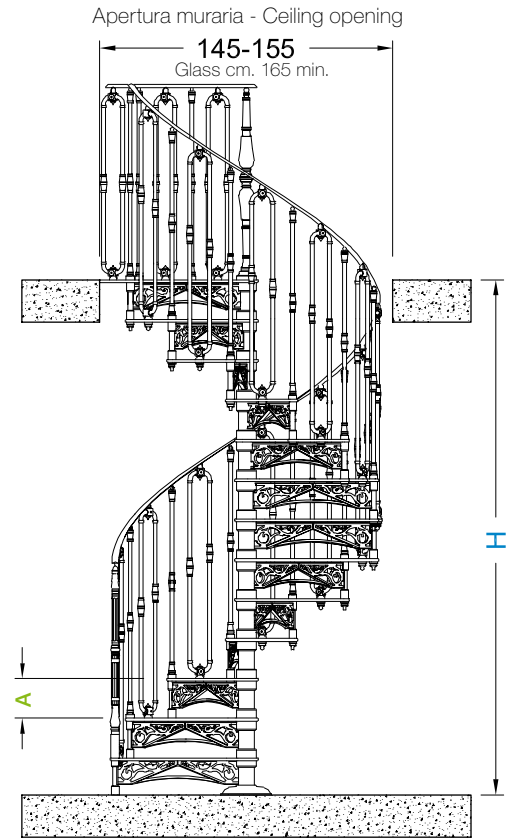
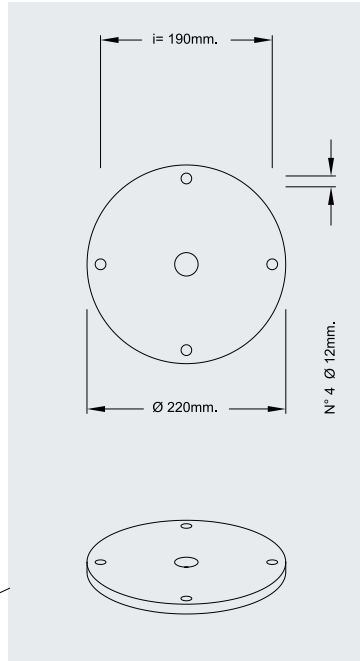
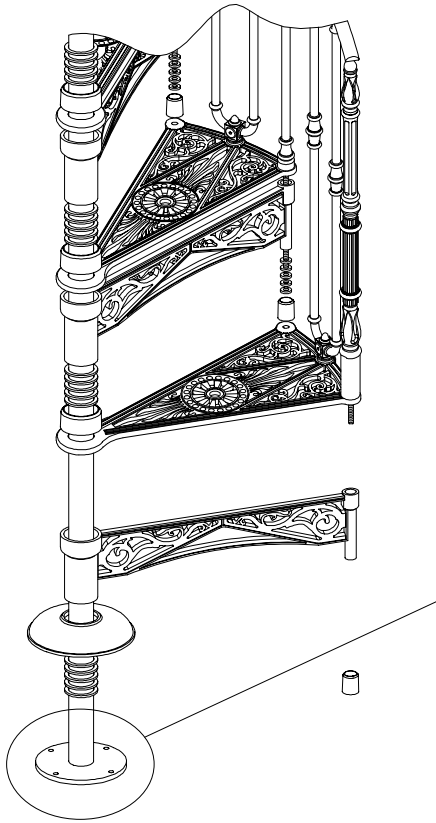

Alzata registrabile
 Step height can be adjusted
 La contremarche est réglable
 Die Stufenhöhe kann eingestellt werden
 La contrahuella se puede regular

Gradini per giro
 Steps per full turn
 Marches par tour
 Stufenanzahl pro Drehung
 Escalones por vuelta

13

(A) Alzata gradino in cm. - Step height in cm - Stufenhöhe in cm. Contremarche en cm. - Contrahuella del escalón en cm

kg. max		20,5	21,0	21,5	22,0	22,5	23,0	
344	N° alzate totali - Total number of steps N.bre de contremarches totales Gesamtzahl der Treppenstufen - N° total de contrahuellas	10	205,0	210,0	215,0	220,0	225,0	230,0
375		11	225,5	231,0	236,5	242,0	247,5	253,0
406		12	248,0	252,0	258,0	264,0	270,0	276,0
437		13	266,5	273,0	279,5	286,0	292,5	299,0
468		14	287,0	294,0	301,0	308,0	315,0	322,0
499		15	310,0	315,0	322,5	330,0	337,5	345,0
530		16	328,0	336,0	344,0	352,0	360,0	368,0
561		17	348,5	357,0	365,5	374,0	382,5	391,0
592		18	372,0	378,0	387,0	396,0	405,0	414,0
623		19	389,5	399,0	408,5	418,0	427,5	437,0
654	20	410,0	420,0	430,0	440,0	450,0	n.d.	

(H) Altezza scala in cm. - Staircase height in cm.
 Treppenhöhe in cm.
 Hauteur de l'escalier en cm - Altura de la escalera en cm.





*Il Caput
re*

*Umpre sott'ni f
quest'emo colle.
E questi vige,
che da tutti parti
De l'altre vige
il grande vedde.
Ma alendo e no
l'intenente
l'asse di la da q
e serrena l'leas
e profusione q
Se nel grasso m
ave per poe
E se non è qua
E come il vento.*

Gianni Lupat

2010 M

Ø 120 cm

Scala a chiocciola modulare con alzata regolabile tramite l'inserzione di distanziali fra i gradini. Gradino in ghisa sferoidale, sottogrado, colonna centrale e capiscala in ghisa; anima interna in acciaio; colonnine (vedere pag. 57), corrimano in alluminio, bulloneria in acciaio inox. Adatta per ambienti interni ed esterni. Colore standard grigio.

Modular spiral staircase with step height adjustable by inserting spacers between steps. Tread in nodular cast iron, undertread decorated, central column, newel posts in cast iron; steel core post; balustrades (see page 57) aluminium handrail, bolts and other fasteners in stainless steel. Suitable for indoor and outdoor use. Standard grey colour.

Escalier en colimaçon modulaire à contremarche réglable grâce à l'introduction d'entretoises entre les marches. Marche en fonte sphéroïdale, contremarche, colonne centrale et premiers balustres en fonte; âme interne en acier; balustres (voir à la page 57) main courante en aluminium, boulonnerie en acier inox. Adapté à un environnement intérieur ou extérieur. Couleur standard gris.

Modulare Wendeltreppe mit einer Steigung, die durch Einfügung von Distanzstücken zwischen den Stufen verändert werden kann; Trittlflächen aus Kugelgraphitgusseisen; Setzfläche, Treppenspindel und Endpfosten aus Gusseisen; Innenkern aus Stahl; Geländer und Geländerpfosten aus Stahl, Handlauf aus Aluminium, Schrauben und Muttern aus Edelstahl. Geeignet für Innen- und Außenräume. Farbe Standard-Grau.

Escalera de caracol modular con contrahuella regulable mediante la inserción de arandelas distanciadoras entre los escalones. Huella de hierro fundido esférico, tabica, columna central y principios o finales de escalera de hierro fundido; ánima de acero; barrotes de aluminio, pernos de acero inoxidable. Adecuada para espacios interiores y exteriores. Color estándar gris.

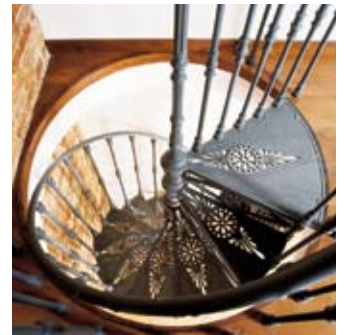



2010 E

Ø 120 cm

Scala a chiocciola modulare con alzata regolabile tramite l'inserzione di distanziali fra i gradini. Gradino in ghisa sferoidale, colonna centrale e capiscala in ghisa ; anima interna in acciaio; colonnine (vedere pag. 57), corrimano in alluminio, bulloneria in acciaio inox. Adatta per ambienti interni ed esterni. Colore standard grigio.

Modular spiral staircase with step height adjustable by inserting spacers between steps. Tread in nodular cast iron, central column, newel posts in cast iron; steel core post; balustrades (see page 57) aluminium handrail, bolts and other fasteners in stainless steel. Suitable for indoor and outdoor use. Standard grey colour.

Escalier en colimaçon modulaire à contremarche réglable grâce à l'introduction d'entretoises entre les marches. Marche en fonte sphéroïdale, colonne centrale et premiers balustres en fonte; âme interne en acier; balustres (voir à la page 57) main courante en aluminium, boulonnerie en acier inox. Adapté à un environnement intérieur ou extérieur. Couleur standard gris.

Modulare Wendeltreppe mit einer Steigung, die durch Einfügung von Distanzstücken zwischen den Stufen verändert werden kann; Trittflächen aus Kugelgraphitgusseisen; Treppenspindel, Endpfosten aus Gusseisen; Innenkern aus Stahl; Geländer und Geländerpfosten aus Stahl, Handlauf aus Aluminium, Schrauben und Muttern aus Edelstahl. Geeignet für Innen- und Außenräume. Farbe Standard-Grau.

Escalera de caracol modular con contrahuella regulable mediante la inserción de arandelas distanciadoras entre los escalones. Huella de hierro fundido esferoidal, columna central y principios o finales de escalera de hierro fundido; ánima de acero; barrotes (ver a la pag. 57) pasamanos de aluminio, pernos de acero inoxidable. Adecuada para espacios interiores y exteriores. Color estándar gris.



□ 2010 M/E
Ø 120 cm



Spirale di luce
The spiral of light
Spirale de lumière
Lichtspiralen
Espiral de luz

Alla funzione di collegamento dei vari ambienti è associato un innovativo sistema di illuminazione a led opzionale (solo per interni).

Its function of linking different areas has been enhanced by an innovative led lighting system as optional (indoor use only).

A la función de liaison entre les différentes pièces est associé un innovant système d'éclairage avec des leds en option (seulement à l'intérieur)

Neben der Verbindungsfunktion kann die Wendeltreppe auch mit einer Beleuchtungsfunktion ausgestattet werden - optional ist ein innovatives Beleuchtungssystem mit LED's erhältlich (nur für Innen).

A la función de conexión de los varios ámbitos es agregado un innovador sistema de iluminación con led opcional (solo para interiores).



2010 M/E
 Ø 120 cm

Pianerottoli
Landings
Marches palières
Treppenausstieg
Rellanos

Pianerottolo di partenza (opzionale)
Bottom landing (optional)
Palier de départ (en option)
Einstiegspodest (auf Wunsch)
Rellano de salida (opcional)

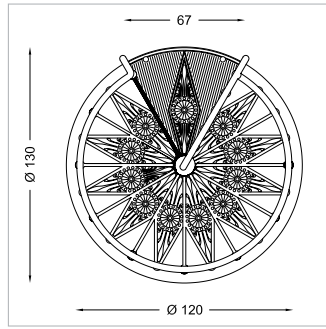

Circolare in ghisa
 Round in cast-iron
 Circulaire en fonte
 Rund aus Gusseisen
 Circular de hierro fundido

Ingresso scala standard
 Standard staircase entrance
 Accès escalier standard
 Standard Treppeneingang
 Entrada de escalera estándar

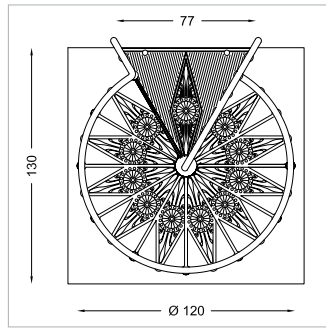
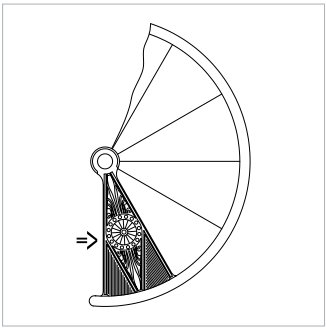

Triangolare in ghisa
 Triangular in cast-iron
 Triangulaire en fonte
 Dreieckig aus Gusseisen
 Triangular de hierro fundido

Ingresso con pianerottolo di partenza
 Starting with landing
 Accès avec palier de départ
 Mit Einstiegspodest
 Entrada con rellano de inicio

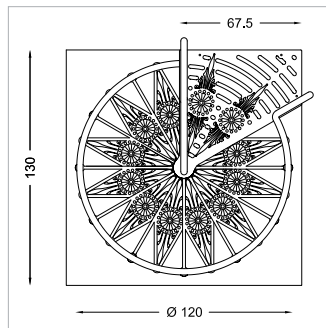
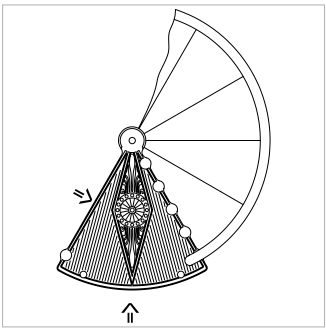

Trapezoidale in acciaio
 Trapezoid in steel
 Trapézoïdale en acier
 Trapezförmig aus Stahl
 Trapezoidal de acero

2010 M/E
Ø 120 cm



Colonnine
Balusters
Balustres
Streben
Barrotes



In ghisa
In cast-iron
En fonte
Gusseisen
De hierro fundido

In acciaio senza decoro
In steel without ornament
En acier sans ornement
Stahl ohne Verzierung
De acero sin decoración

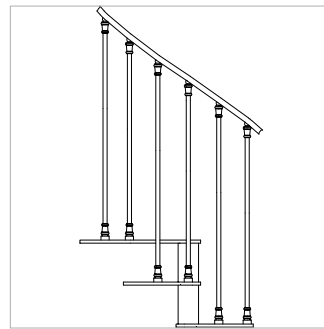

In ghisa e acciaio
In cast-iron and steel
En fonte et acier
Gusseisen und Stahl
De hierro fundido y acero

In acciaio decoro geometrico
In steel geometrical ornament
En acier ornement géométrique
Stahl geometrische Motive
De acero decoración geométrica

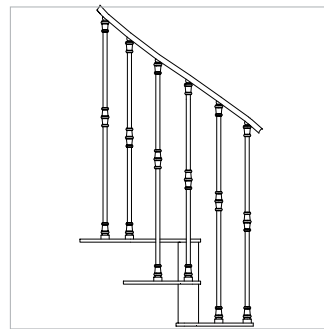

In vetro
In glass
En verre
Aus Glas
De vidro

In acciaio decoro floreale
In steel floral ornament
En acier ornement floral
Stahl blumenverzierung
De acero decoración floral

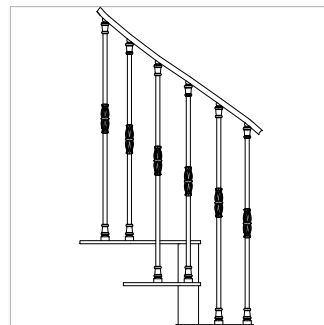

2010 M/E
 Ø 120 cm

Balaustra di protezione
Protective railings
Garde-corps
Schutzbalustraden
Balaustradas de protección

Corrimano in alluminio disponibile in diverse metrature
 Aluminium handrail available in different lengths
 Main courante en aluminium disponible en différents métrages
 Handlauf aus Aluminium in verschiedenen Längen lieferbar
 Pasamanos de aluminio disponible en varios metrajes

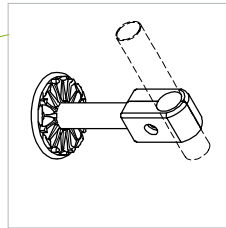
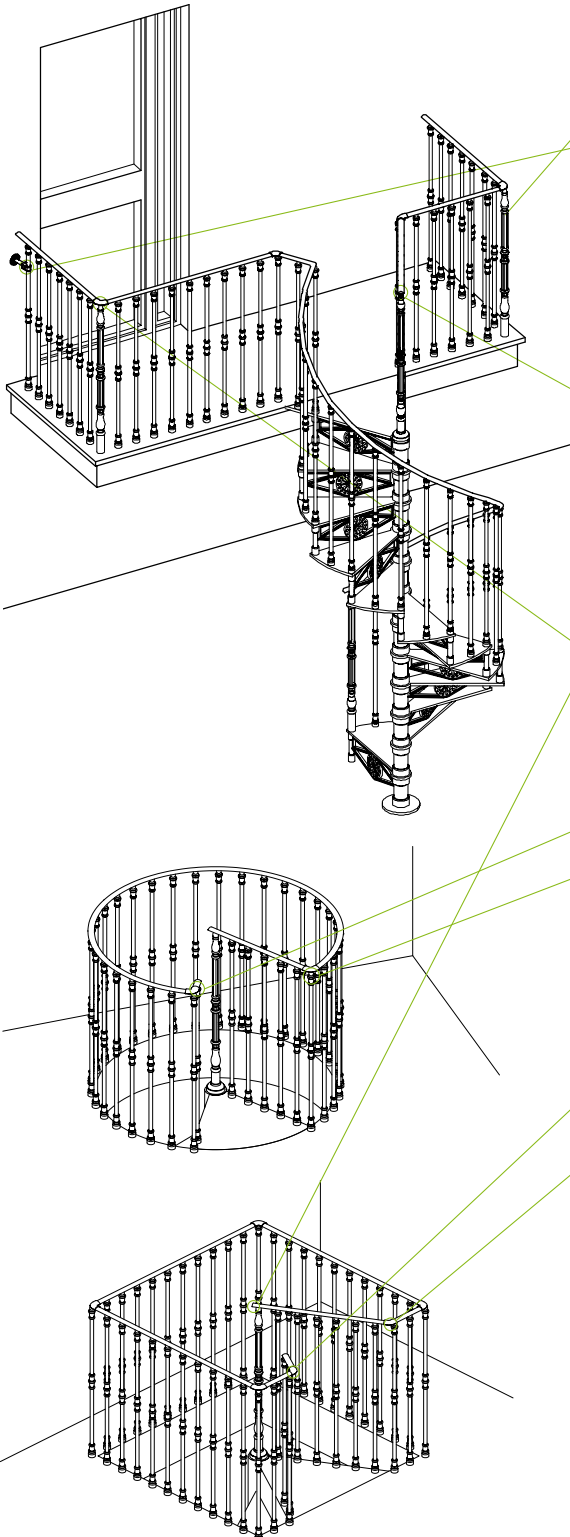

S0091.CSP.0000S

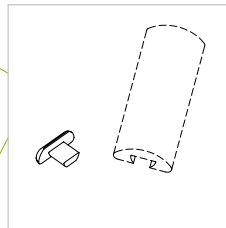
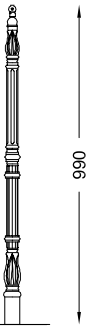

S0016.CSP.0000S

S0019.CSP.000LS

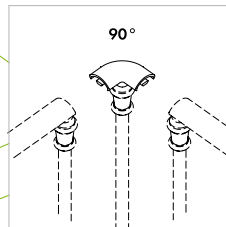
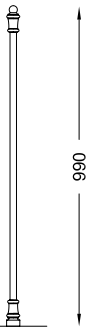

S0088.CSP.0000S

S0019.CSP.000FS

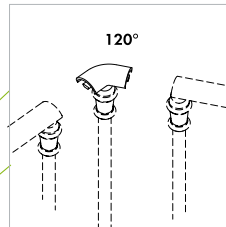
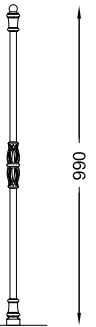

S0089.CSP.0000S

S0019.CSP.000TS

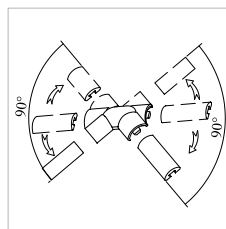
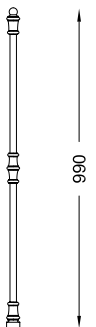

S0035.CSP.0000S



2010 M/E
 Ø 120 cm

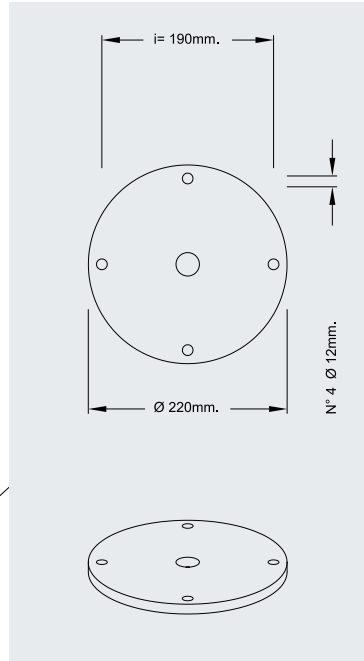
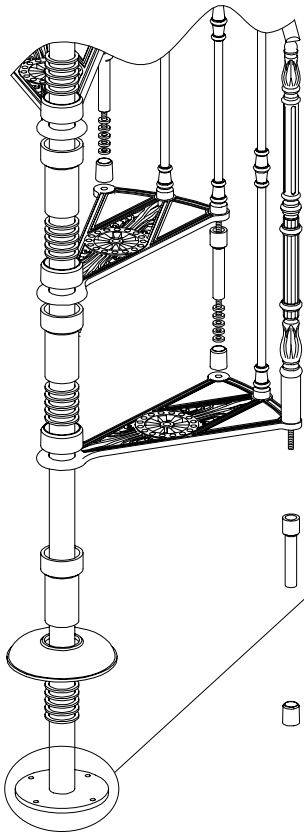

Apertura muraria - Ceiling opening

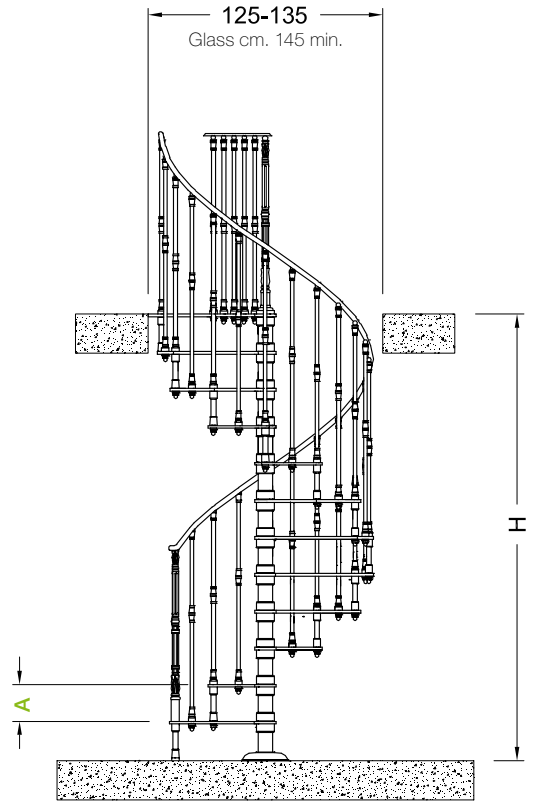

Alzata registrabile
 Step height can be adjusted
 La contremarche est réglable
 Die Stufenhöhe kann eingestellt werden
 La contrahuella se puede regular

Gradini per giro
 Steps per full turn
 Marches par tour
 Stufenanzahl pro Drehung
 Escalones por vuelta

12

(A) Alzata gradino in cm. - Step height in cm - Stufenhöhe in cm. Contremarche en cm. - Contrahuella del escalón en cm

kg. max			20,5	21,0	21,5	22,0	22,5	23,0	
280	N° alzata totali - Total number of steps N.bre de contremarches totales Gesamtzahl der Treppenstufen - N° total de contrahuellas	10	205,0	210,0	215,0	220,0	225,0	230,0	(H) Altezza scala in cm. - Staircase height in cm. Treppenhöhe in cm. Hauteur de l'escalier en cm - Altura de la escalera en cm.
305		11	225,5	231,0	236,5	242,0	247,5	253,0	
330		12	248,0	252,0	258,0	264,0	270,0	276,0	
355		13	266,5	273,0	279,5	286,0	292,5	299,0	
380		14	287,0	294,0	301,0	308,0	315,0	322,0	
405		15	310,0	315,0	322,5	330,0	337,5	345,0	
430		16	328,0	336,0	344,0	352,0	360,0	368,0	
455		17	348,5	357,0	365,5	374,0	382,5	391,0	
480		18	372,0	378,0	387,0	396,0	405,0	414,0	
505		19	389,5	399,0	408,5	418,0	427,5	437,0	
530	20	410,0	420,0	430,0	440,0	450,0	n.d.		

2010S ON REQUEST





REALIZZAZIONI SPECIALI



SPECIAL PROJECTS
RÉALISATIONS SPÉCIALES
SPEZIALANFERTIGUNGEN
REALIZACIONES ESPECIALES

Modus è in grado di proporVi una serie di soluzioni studiate su misura che rispondono alle più diverse esigenze d'installazione. Il ns. ufficio tecnico è in grado di supportarvi e tradurre in realtà le vostre idee.

Modus can offer customers a variety of made-to-measure solutions to suit a wide range of installation needs. Our Technical Office is able to give full assistance to turn your ideas into finished products.

Modus est en mesure de vous proposer toute une série de solutions étudiées sur mesure et répondant aux exigences d'installation les plus diverses. Notre bureau technique est à votre disposition pour vous fournir tout le support nécessaire vous permettant de transformer vos idées en réalité.

Modus kann Ihnen eine Reihe individueller Lösungen anbieten, die nach Ihren Maßen entwickelt werden, um verschiedenen Installationsanforderungen gerecht zu werden. Unsere Technische Planung unterstützt Sie, damit Ihre Ideen verwirklicht werden können.

Modus está en condiciones de proponer una serie de soluciones estudiadas a medida que responden a las necesidades de instalación más variadas. Nuestra oficina técnica le ayudará a convertir en realidad sus ideas.



Scale a doppia o più rampe
Staircase with two or more flights
Escaliers à rampe double ou plus
Treppen für zwei oder mehr Etagen
Escaleras de dos o más rampas



REALIZZAZIONI SPECIALI
SPECIAL PROJECTS
RÉALISATIONS SPÉCIALES
SPEZIALANFERTIGUNGEN
REALIZACIONES ESPECIALES



Scale di diametro a richiesta
Stairs with diameter on request
Escaliers avec diamètre sur demande
Treppen mit Durchmesser nach Wunsch
Escaleras del diámetro que se solicite

Gradini realizzati in lamiera di acciaio intagliati
Steps made in engraved sheet steel
Marches réalisées en tôle d'acier découpée
Mit Zierschnitt versehene Stufen aus Stahlblech
Peldaños de chapa de acero ranurados





REALIZZAZIONI SPECIALI
SPECIAL PROJECTS
RÉALISATIONS SPÉCIALES
SPEZIALANFERTIGUNGEN
REALIZACIONES ESPECIALES



Flange e staffe di fissaggio particolari
Special fixing flanges and brackets
Brides et dispositifs de fixation particuliers
Besondere Flansche und Befestigungsbügel
Bridas y abrazaderas de fijación especiales

REALIZZAZIONI SPECIALI
SPECIAL PROJECTS
RÉALISATIONS SPÉCIALES
SPEZIALANFERTIGUNGEN
REALIZACIONES ESPECIALES



Pianerottoli speciali
Special landings
Paliers spéciaux
Spezialpodeste
Rellanos especiales

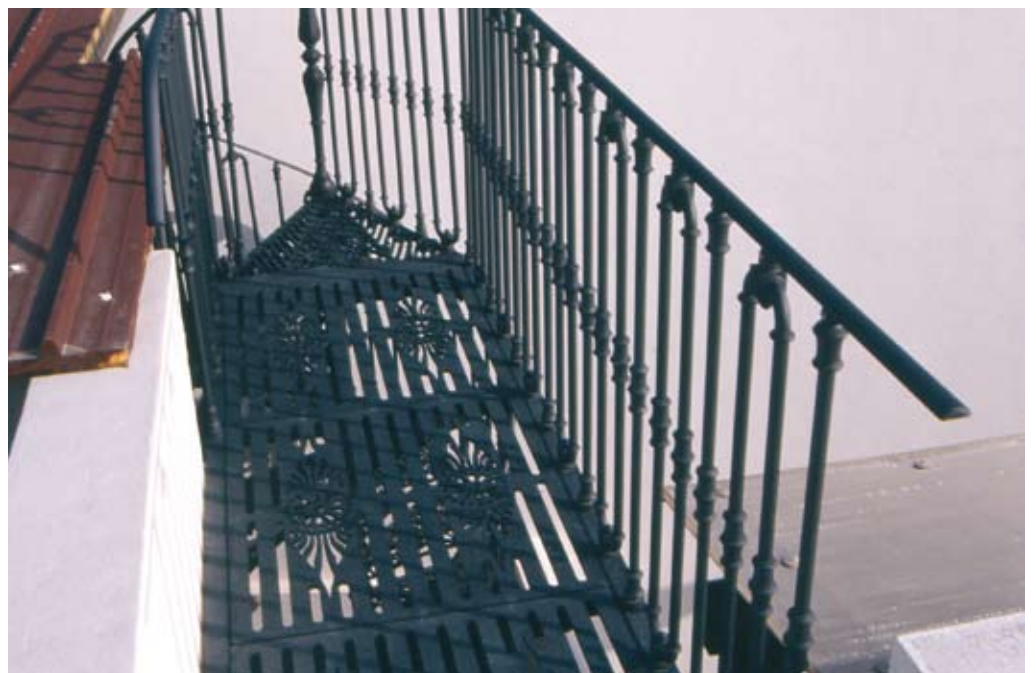



A brand by NERI s.p.a.
S.S. Emilia 1622
47020 Longiano (FC)
T +39 0547 652111
F +39 0547 54074
www.neri.biz
www.modus.sm